



WONDERFIRE ELECTRONIC VALVE

INSTALLATION & OPERATING MANUAL

Nectre Wonderfire fire boxes are approved to be installed as a zero clearance firebox and are designed to operate on Natural Gas.
Approval Number: AGA 4464 G

Installed primarily as a decorative appliance. Not certified as a Space Heater.

VERSION 1.4

WARRANTY INFORMATION

The benefits provided to you under the following warranty are in addition to any other rights and remedies available to you under the law.

1. Warranty

If:

- (a) during the first 10 years from the date of purchase (Firebox Warranty Period), there is a defect in the firebox of the Gas Burner; or
- (b) during the first 2 years from the date of purchase (Parts Warranty Period), there is a defect in the gas valves or other parts of the Gas Burner,
due to improper workmanship or material, Glen Dimplex will replace or repair the Gas Burner without charge. Any replacement product is warranted only for the time remaining on the original Firebox Warranty Period or the Parts Warranty Period as relevant.

2. Registration

All in and out of warranty claims and service requests are to be emailed to: service@glendimplex.com.au

The email should include the following information:

- Proof of purchase—A copy of the customer's invoice.
- Store details and contact person. (Please ensure ALL details are correct)
- All relevant customer details, if not on the proof of purchase
- Detailed report of the issue with pictures where possible showing any damage or technical issue.

3. Exclusions

Glen Dimplex is not obliged to replace or repair the Gas Burner under clause 1 if:

- (a) it has been improperly stored, installed, connected, used, operated or repaired, or damaged, abused, tampered with, altered (without our written approval), or not maintained in strict accordance with our installation and operating instructions; or
- (b) it has been installed in an outdoor setting.

4. Limit of Liability

The warranty provided under this warranty is limited to replacement or repair of the Gas Burner only, at our option. To the extent permitted by law, Glen Dimplex excludes liability for consequential loss or any other loss or damage caused to property or persons arising from any cause whatsoever, and damage arising from normal wear and tear.

5. Claiming under the Warranty

In order to claim under this warranty you must, within the Firebox Warranty Period or the Parts Warranty Period (as relevant), contact Glen Dimplex, providing the original proof of purchase and the details below:

Supplier Name _____

Date Of Purchase / settlement of property if new home _____

Model / Serial Number _____

This warranty does not cover the cost of claiming under the warranty or transporting the Real Flame Gas Burner to and from the supplier.

Our goods come with guarantees that cannot be excluded under the Australian Consumer Law. You are entitled to a replacement or refund for a major failure and for compensation for any other reasonably foreseeable loss or damage. You are also entitled to have the goods repaired or replaced if the goods fail to be of acceptable quality and the failure does not amount to a major failure.

If you would like to speak to someone about your Gas Burner or claiming under this warranty, please contact the Service Warranty Desk on 1300 554 155.

Glen Dimplex Australia Pty Ltd ACN 69 118 275 460
Head Office: 8 Lakeview Drive, Scoresby, VIC 3179
Telephone: 1300 554 155 Facsimile: (03) 8706 2001

INSTALLATION NOTICE

- The installation of this appliance is only to be carried out by an authorised person in accordance with the Manufacturer's Instructions, local gas fitting regulations, AS/NZS5601.1-2013 installation code for gas burning appliances and any other relevant statutory regulations.
- In all cases the installation of this appliance shall meet the requirements as set out in AS/NZS5601.1-2013

- NOTE: A slight smell may be apparent for the first few hours of use. This is due to the heat resistant paint curing. It is recommended to open windows in the room for the first lighting of the fire. In some instances a slight discolouration may occur inside the firebox. This is a normal condition and is not covered by warranty.

IMPORTANT SAFETY NOTICES

- DO NOT PLACE ARTICLES ON OR AGAINST THIS APPLIANCE.
- DO NOT USE OR STORE FLAMMABLE MATERIAL NEAR THE APPLIANCE.
- DO NOT SPRAY AEROSOLS IN THE VICINITY OF THIS APPLIANCE WHILST IT IS IN OPERATION.
- CARE MUST BE TAKEN TO ENSURE THAT ANY RETURN AIR REGISTER OR EXHAUST SYSTEM DOES NOT ADVERSELY AFFECT THE OPERATION OF THE APPLIANCE OR DRAUGHT OF CHIMNEY OR FLUE.
- DO NOT MODIFY THIS APPLIANCE.
- THIS APPLIANCE IS DESIGNED TO OPERATE WITH LUMINOUS FLAMES. THIS MAY EXHIBIT SLIGHT CARBON DEPOSITS.

VENTILATION REQUIREMENTS

Permanent ventilation of the room where the fire is to be situated is essential while fire is in operation. The room must have a minimum cross sectional area of 40,000sq mm of effective ventilation.

It is recommended that you service your gas fire every 2 years.

WARNING

This firebox has a naked flame, care should be taken when it is operating if children or the infirm are in close proximity. For protection of young children or the infirm, a secondary guard is required. A safety screen is recommended if constant supervision is not possible. It is recommended that a secondary guard complying with AS-NZS2286 be installed.

The appliance is not intended for use by persons (including children) with reduced physical, sensory or mental capabilities, or lack of experience and knowledge, unless they have been given supervision or instruction concerning use of the appliance by a person responsible for their safety. Children should be supervised to ensure that they do not play with the appliance.

THIS IS PRIMARILY A DECORATIVE APPLIANCE AND IS NOT CERTIFIED AS A SPACE HEATER.

CONTENTS

Contents	4
Data Plate	5
Dimensions	5
Operating Instructions - Customer	6
Technical Data	8
System Description	9
Installation	10
Operating Procedure	12
Installation Instructions - Installer	17
Commissioning	19
Maintenance/Fault Finding	19
Servicing Details	19
Fault Finding Chart	22
Sequence of Operation	23
Regulator Adjustment & Conversion Details	23
Wiring Diagram	24
Glen Dimplex contact information	28

DATA PLATE (Affixed to the base of the unit for reference to gas pressure & consumption)

AF18 OF Automatic valve (Sit Proflame)

Gas	Injector Size (mm)	TPP	N.G.C. (Mj/Hr)
Natural Gas	1 x injector multiport 7 ports x 1.25	0.88 kPa high	35 high

DIMENSIONS

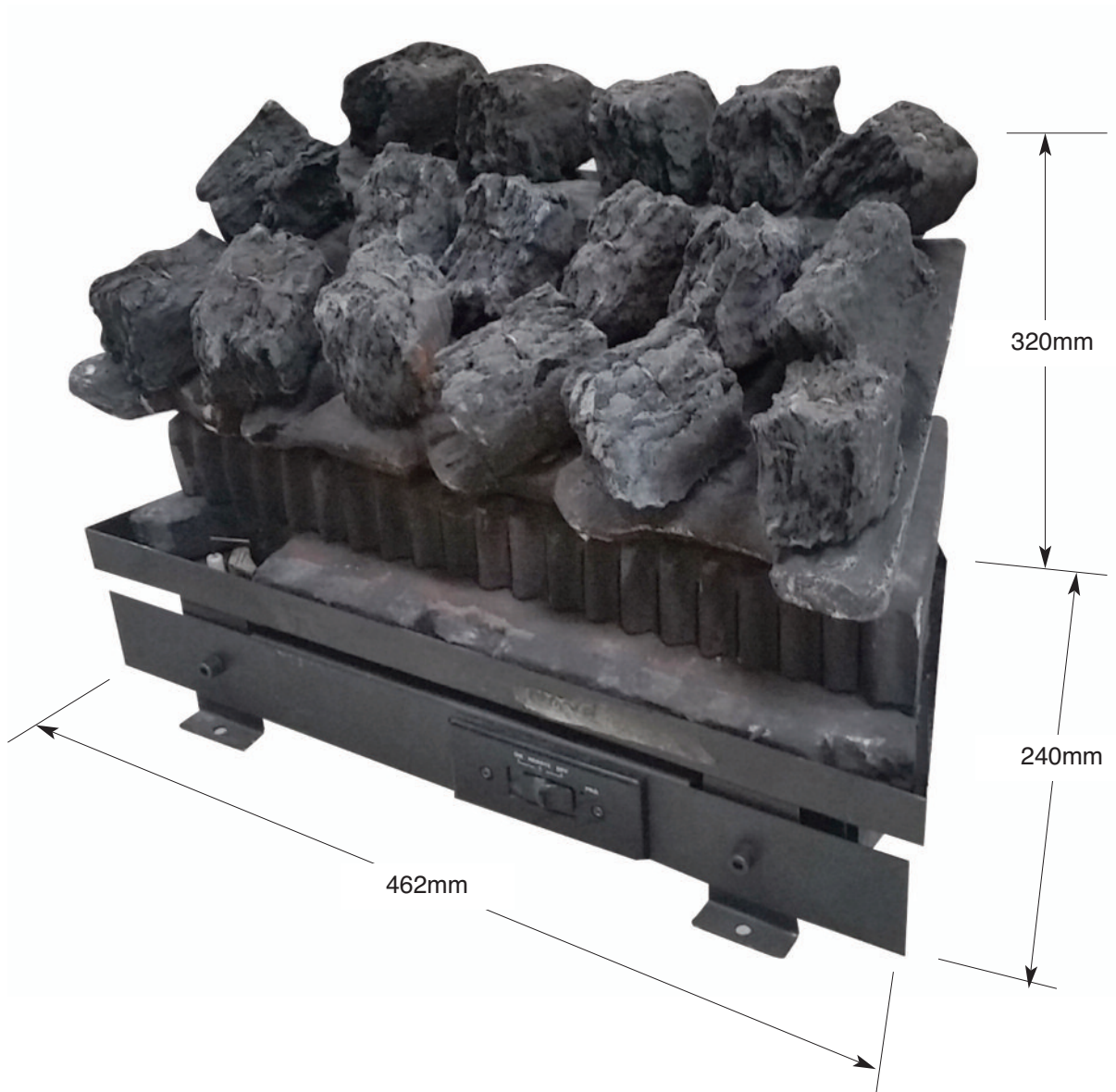

OPERATING INSTRUCTIONS - Customer

Congratulations on your purchase of the Nectre Wonderfire.

This gas coal fire has been bench tested in the factory to ensure satisfactory operation.

Safety First!

- The appliance is designed to simulate a coal fire and as such working surfaces can become quite hot. Do not touch them. Always take extra care with young children or the infirm.
- A separate fireguard can be used to protect young children or the infirm.
- DO NOT PLACE ARTICLES ON OR AGAINST THIS APPLIANCE.
- DO NOT USE OR STORE FLAMMABLE MATERIALS NEAR THIS APPLIANCE.
- DO NOT SPRAY AEROSOLS IN THE VICINITY OF YOUR FIRE WHILST IT IS IN USE.
- DO NOT OPERATE WITH PANEL COVERS, OR GUARDS REMOVED FROM THIS APPLIANCE.
- Primarily a decorative appliance - not certified as a space heater.
- The unit must be installed and serviced by a qualified person.
- Wash hands after handling coals and ensure children do not handle them as the colouring may contain toxic dyes.

Caring for your Nectre Wonderfire

Your Nectre Wonderfire has been designed for ease of use and is very easy to maintain. The fire is a sealed unit and there are no user serviceable components inside, other than the batteries.

To clean:

- Metal surfaces; simply wipe over with a damp cloth.
- Do not use harsh cleaning agents or solvents.
- Ceramic coals; Lightly vacuum with a soft brush attachment.
- Pilot Light; check for lint and dust, vacuum as necessary.
- For units with a fan, check the air intake at the front of the fire is free of lint and dust, vacuum and clean as necessary.
- Do not attempt to clean the unit whilst it is operating (including Pilot Light) or whilst it is hot.
- After a number of hours of use of the Fire, there may be a slight blackening of some parts the coals. This is normal and helps enhance the realistic coal fire look.

If your Nectre Wonderfire needs servicing

Your Nectre Wonderfire is reliably designed and built to a fully tested design. If the fire has been only recently installed and fails to operate, you should call the installer to solve any problems. Check with the installer that installation has been carried out correctly, that the gas lines have been bled and gas cocks are turned on. If the problem is not related to the installation, please call your place of purchase and let them know what model you have installed and a description of the problem. If necessary, they will refer back to the manufacturer.

If after some use the appliance fails to operate, you can telephone us direct:

Phone: 1300 554 155

THIS APPLIANCE REQUIRES FRESH AIR TO OPERATE SAFELY. THE ROOM WHERE THIS APPLIANCE IS INSTALLED MUST HAVE PERMANENT VENTILATION FROM OUTDOORS. THIS VENTILATION MUST NOT BE MODIFIED.

OPERATING INSTRUCTIONS - Customer

The Nectre Wonderfire has fully automatic controls and must be connected to gas and have good batteries to operate. Before trying to turn on your fire for the first time check that it has been properly installed and tested by a qualified installer.

Turning the Nectre Wonderfire ON

1. Read the instructions.
2. Ensure the gas supply is turned on and the front switch set to REMOTE. Using the remote control press the ON/OFF button. The unit should beep and the igniter spark, the pilot light and then the main burner ignite. If the unit has not been used for some time it may take a while for the gas to come through.

OR

1. Using the control panel press slide the switch to ON.
2. The burner of the fire will light with a soft blue flame. Leave the fire on HIGH and after about ten minutes the top of the flames will become more orange and the coals will start to glow red like a real coal fire.
3. The fire can be managed by turning the flame down, setting the thermostat to raise or lower the flame or to turn the fire off when a preset temperature is reached.

To turn the Fire off simply press the ON/OFF switch on the remote or slide the front switch to OFF.

Batteries, installation and replacement

Remote Batteries: A battery icon appears on the display when the batteries are low. They should be replaced with 3 AAA batteries

Unit Batteries: If the receiver batteries are low then no beep will be heard when it receives the on/off command from the remote.

The appliance can be turned on and off with the front slide switch until the batteries are replaced. Remove the switch front cover by removing the two screws. Slide the switch to the OFF position.

Open the battery chamber and fit 4 new AA batteries. Close the chamber, replace the front cover and slide the switch to REMOTE.

WARNING: Do not attempt to replace batteries whilst the unit is hot. Allow it to cool down first if required. Note: Do not mix old and new batteries.



TECHNICAL DATA

Remote Control

Supply voltage	4.5 V (three 1.5 V AAA batteries)
----------------	-----------------------------------

Ambient temperature ratings	0-50 DEG C (32-122 DEG F)
-----------------------------	---------------------------

Radio frequency	315 MHz
-----------------	---------

Receiver

Supply voltage	6.0 V (four 1.5 V AA batteries)
----------------	---------------------------------

Ambient temperature ratings	0-60 DEG C (32-140 DEG F)
-----------------------------	---------------------------

Radio frequency	315 MHz
-----------------	---------

WARNING

The transmitter and receiver are radio frequency devices.

Placing the receiver in or near metal may severely reduce the signal range.

ATTENTION!

- Turn “off” the main gas supply of the appliance during installation or maintenance of the receiver.
- Place the receiver’s 3 position slider switch in the “off” position during installation or maintenance.
- Turn “off” main gas supply to the appliance prior to removing or reinserting the batteries in the receiver.

SYSTEM DESCRIPTION

The Proflame Remote Control System consists of two elements.

1. Proflame transmitter.
2. Proflame receiver and wiring harness to connect the receiver to the gas valve stepper motor.

TRANSMITTER (REMOTE CONTROL WITH LCD DISPLAY)

The Proflame Transmitter uses a streamline design with a simple button layout and informative LCD display (Fig.1)

The Transmitter is powered by 3 AAA type batteries.

A Mode Key is provided to index between the features and a thermostat key is used to turn on/off or index through thermostat functions (Fig 1&2)



Fig. 1: Proflame Transmitter.

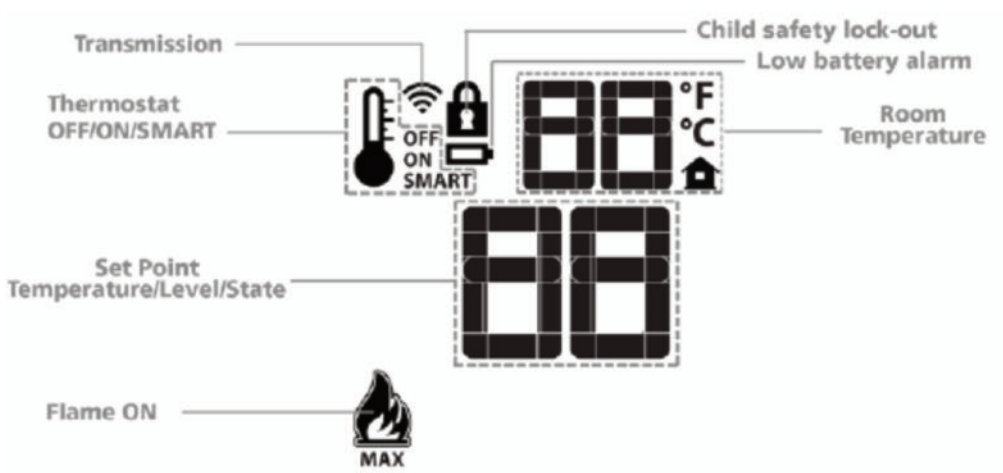

Fig. 2: Transmitter LCD display.

SYSTEM DESCRIPTION

RECEIVER

The Proflame Receiver (Fig. 3) connects directly to the gas valve and stepper motor with a wiring harness. The Receiver is powered by 4 AA type batteries. The receiver accepts commands via radio frequency from the transmitter to operate the appliance in accordance with the particular Proflame system configuration. The receiver three position slider switch can be set to one of three positions. ON (Manual Override), Remote (Remote Control) or Off.

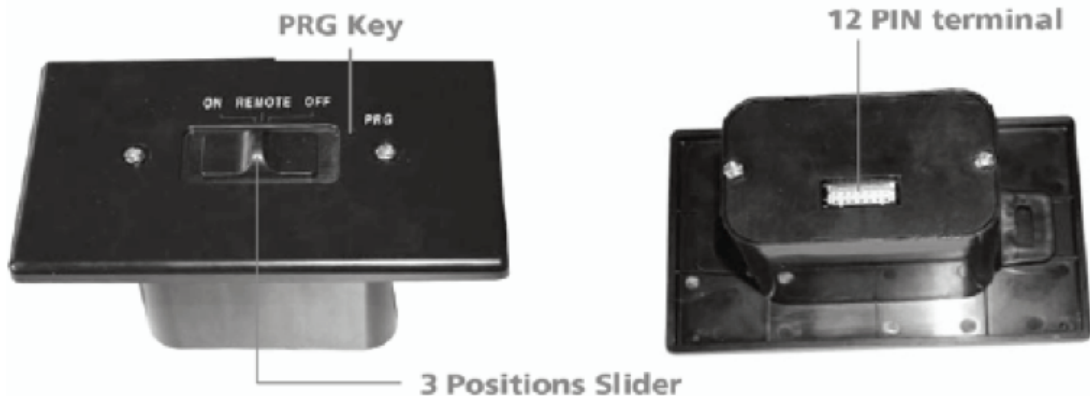

Fig.3: Proflame Receiver body.

INSTALLATION

Hearth Mounting

1. Connect the wiring harness to the back of the Receiver.
2. Install the 4 AA type batteries in the battery compartment with the correct polarity.
3. Make sure the receiver and cover plate words "ON" and "UP" are on the same side.
4. Place the slider into the cover plate.
5. Align the slider with the switch on the receiver and couple the switch into the slider.
6. Using the two screws provided, secure the cover plate to the receiver.

AC/DC Power Pack

Your Nectre Wonderfire comes with a AC switch mode power pack which is required to be plugged into a separate 10amp 240VAC outlet.

Output = 7.5V DC 600Ma

Input = 100-240V ac 50/60Hz

Short circuit and overload protection

Batteries are required in the receiver model for the Nectre Wonderfire to operate.

It is recommended that the batteries in both the remote and receiver are replaced at the beginning of each new winter season to ensure safe and reliable operation of your Nectre Wonderfire.

NOTE:

The Nectre Wonderfire has been manufactured to operate on batteries only when there is a power failure. Battery life will be significantly reduced.



OPERATING PROCEDURE

Initialising the system for the first time

Install the 4 AA batteries into the receiver battery bay. Note the polarity of battery and insert into the battery bay as indicated on the Battery cover (+/-). Place the 3 position slider switch in the "Remote" position.

Using the end of a paper clip, or other similar object, insert the end of the paper clip into the hole marked "PRG" on the Receiver front cover. The Receiver will "beep" three (3) times to indicate that it is ready to synchronize with a Transmitter. Install the 3 AAA type batteries in the Transmitter battery bay, located on the base of the Transmitter. With the batteries already installed in the Transmitter, push the On button. The Receiver will "beep" four times to indicate the Transmitter's command is accepted and sets to the particular code of that Transmitter. The system is now initialized.

Temperature Indication Display

With the system in the "OFF" position, press the Thermostat Key and the Mode Key at the same time. Look at the LCD screen on the Transmitter to verify that a C or F is visible to the right of the Room Temperature display. (Fig. 6)

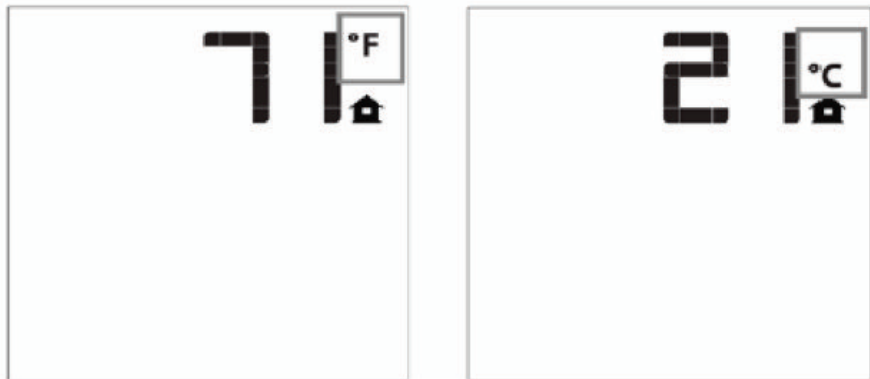

Fig. 6: Remote Control display in Faranheit and Celcius



Fig. 7: Remote Control display

OPERATING PROCEDURE (continued)

Turn on the appliance

Press the ON/OFF Key on the Transmitter. The Transmitter display will show all active icons on the screen. At the same time the Receiver connects the thermopile to the gas valve millivolt coil and the appliance main burner turns on. A single "beep" from the Receiver will confirm reception of the command.

Turn off the appliance

Press the ON/OFF Key on the Transmitter. The Transmitter LCD display will only show the room temperature and icon (Fig.7). At the same time the Receiver disconnects the thermopile from the gas valve millivolt coil and the appliance burner turns off. A single "beep" from the Receiver confirms reception of the command.

Remote Flame Control

The Proflame GTM has six (6) flame levels. With the system on, and the flame level at the maximum in the appliance, pressing the Down Arrow Key once will reduce the flame height by one step until the flame is turned off. The Up Arrow Key will increase the flame height each time it is pressed. If the Up Arrow Key is pressed while the system is on but the flame is off, the flame will come on in the high position. (Fig. 8 & 9) A single "beep" will confirm reception of the command.



Flame Off



Flame Level 1



Flame Level 5



Flame Level Maximum

Fig. 9

Fig. 8

OPERATING PROCEDURE (continued)

Room Thermostat (Transmitter Operation)

The Remote Control can operate as a room thermostat. The thermostat can be set to a desired temperature to control the comfort level in a room. To activate this function, press the Thermostat Key (Fig. 1). The LCD display on the Transmitter will change to show that the room thermostat is "ON" and the set temperature is now displayed (Fig. 10). To adjust the set temperature, press the Up or Down Arrow Keys until the desired set temperature is displayed on the LCD screen of the Transmitter.

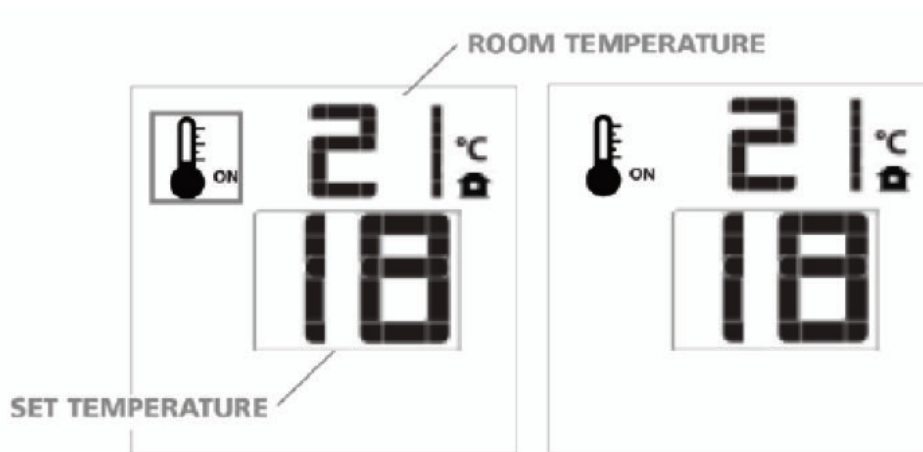

Fig. 10

Fig. 11

Smart Thermostat (Transmitter Operation)

The Smart Thermostat function adjusts the flame height in accordance to the difference between the set point temperature and the actual room temperatures. As the room temperature gets closer to the set point the Smart Function will modulate the flame down. To activate this function, press the Thermostat Key (Fig. 1) until the word "SMART" appears to the right of the temperature bulb graphic (Fig. 12). To adjust the set temperature, press the Up or Down arrow Keys until the desired set point temperature is displayed on the LCD screen of the Transmitter (Fig. 13).

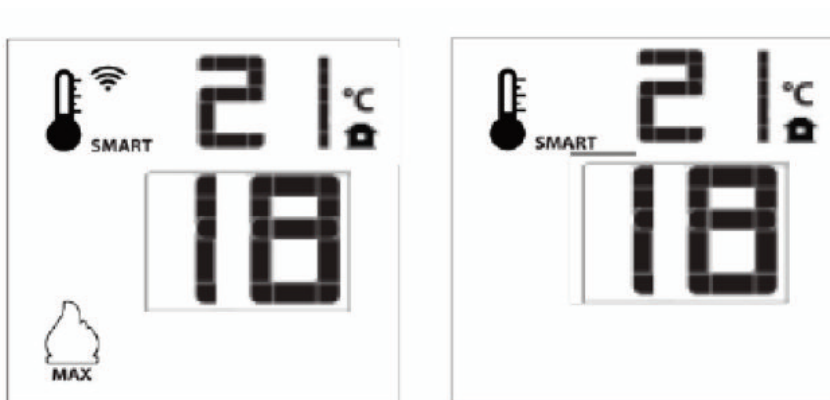

Fig. 12: Smart flame function

Fig. 13

OPERATING PROCEDURE (continued)

Key Lock

This function will lock the keys to avoid unsupervised operation.

To activate this function, press the MODE and the UP Arrow Key at the same time (Fig. 18).

To de-activate this function, press the MODE and the UP Arrow Key at the same time.

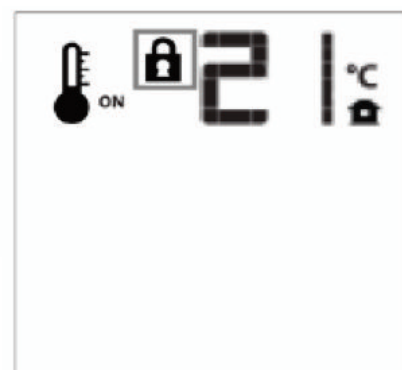

Fig. 18

Low Battery Power Detection

Transmitter

The life span of the remote control batteries depends on various factors: quality of the batteries used, the number of ignitions of the appliance, the number of changes to the room thermostat set point, etc.

When the Transmitter batteries are low, a Battery Icon will appear on the LCD display of the Transmitter (Fig. 19) before all battery power is lost. When the batteries are replaced this icon will disappear.

Receiver

The life span of the Receiver batteries depends on various factors: quality of the batteries used, the number of ignitions of the appliance, the number of changes to the room thermostat set point, etc.

When the Receiver batteries are low, No "beep" will be emitted from the Receiver when it receives an On/Off command from the Transmitter. This is an alert for a low battery condition for the Receiver. When the batteries are replaced the "beep" will be emitted from the Receiver when the ON/OFF Key is pressed (See Initialization of The System).

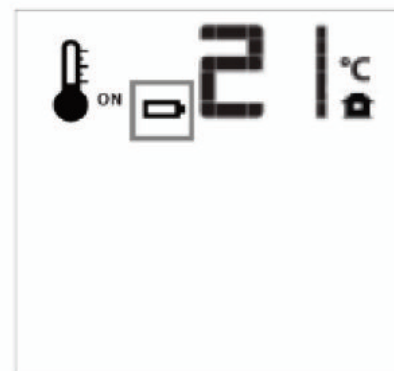

Fig. 19

Manual bypass of the remote system

If the batteries of the Receiver or Transmitter are low or depleted, the appliance can be turned on manually by sliding the three position slider switch on the Receiver to the ON position. This will bypass the remote control feature of the system and the appliance main burner will come on if the gas valve is in the "On" position.

OPERATING PROCEDURE (continued)

WARNING

Fire Hazard. Can cause severe injury or death

The Receiver causes ignition of the appliance. The appliance can turn on suddenly. Keep away from the appliance burner when operating the remote system or activating manual bypass of the remote system.

CAUTION

Property Damage Hazard.

Excessive heat can cause property damage.

The appliance can stay lit for many hours. Turn off the appliance if it is not going to be attended for any length of time.

Always place the Transmitter where children can not reach it.

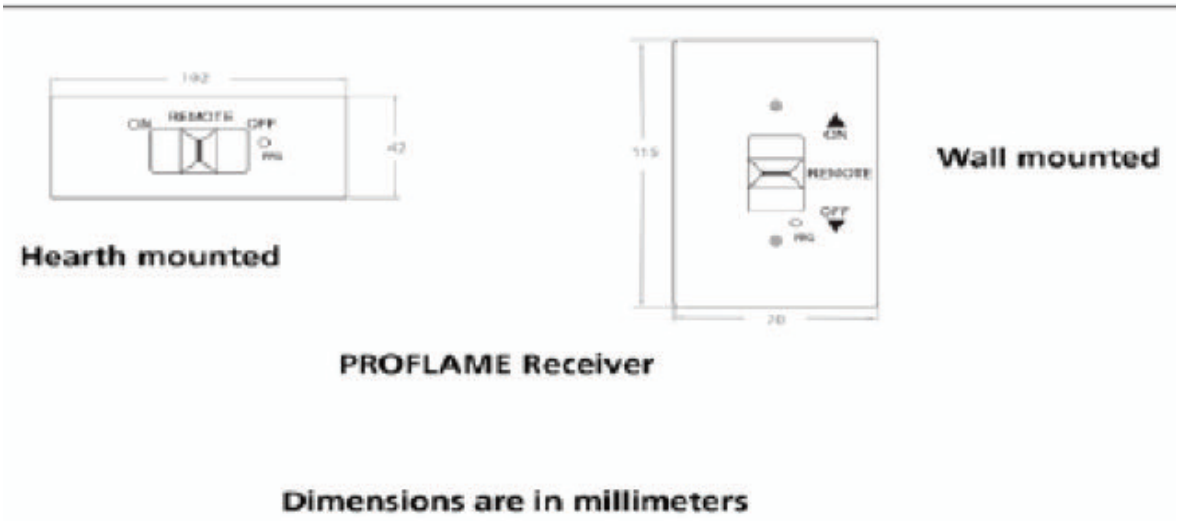
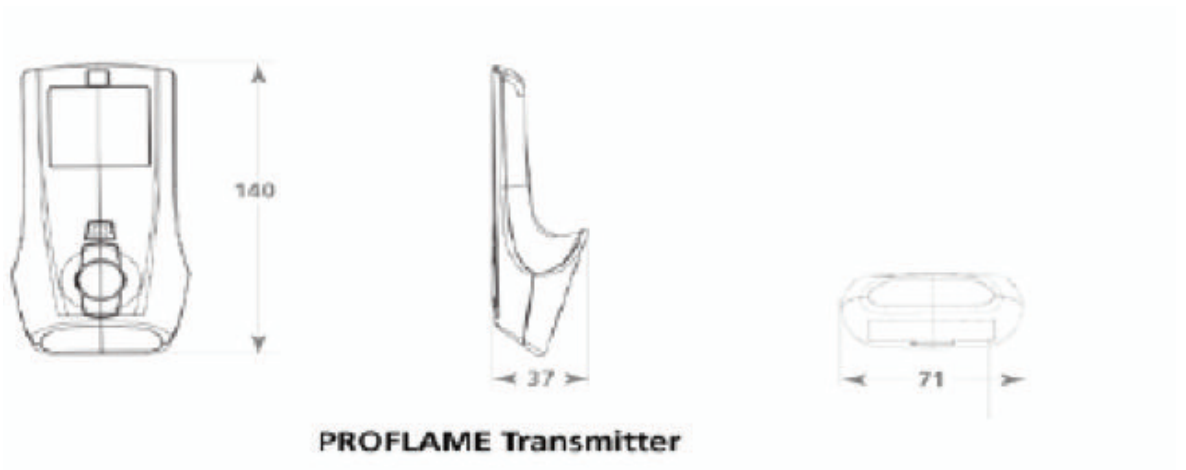

INSTALLATION INSTRUCTIONS

TO THE INSTALLER

This appliance must only be installed by an authorized person in accordance with these instructions and with the gas installation code. Please install the batteries and test the appliance to ensure correct operation as part of the installation.

If you have any questions please contact Glen Dimplex Australia.

Preliminary

- This appliance must be installed by an Authorised person.
- This appliance must be installed in accordance with the Gas Installation Code AS5601 Clauses 5.12.13.2 to 5.12.13.5.
- This appliance must be installed in accordance with; the manufactures installation instructions, Municipal building codes, and any other relevant statutory regulations
- The Nectre Wonderfire Gas Fire is only to be used with natural gas. Please refer to the “Servicing Details” section of these instructions.
- It is recommended that a secondary guard complying with AS 2286 be installed.
- The guard is fitted to this appliance to reduce the risk of fire or injury from burns and no part of it should be permanently removed. For protection of young children or the infirm, a secondary guard is required.
- Ensure that loose fabrics such as curtains and furniture cannot touch the appliance. It is recommended that a fire guard be used with the appliance.
- The overall dimensions of the fire is 465mm wide (front), 325mm wide (rear) x 250mm Deep x 320mm high. (See below for minimum fire place dimensions).
- The appliance may be installed in an existing open fireplace (as a Type 1 appliance), in an existing fireplace with the Nectre fan assisted convector box (as a Type 1 appliance) or in a purpose built enclosure with the Nectre fan assisted convector (zero clearance) box (as Type 2 appliance).
- If fitting the Wonderfire with the FFB firebox, please also refer to the Instructions for the “Nectre Wonderfire FFB”
- Packaging and transit protection must be removed from the appliance prior to installation. This includes pallet, plastic wrap, temporary labels and foam protection.

THIS APPLIANCE REQUIRES FRESH AIR TO OPERATE SAFELY. THE ROOM WHERE THIS APPLIANCE IS INSTALLED MUST HAVE PERMANENT VENTILATION FROM OUTDOORS, IN ACCORDANCE WITH THE VENTILATION REQUIREMENTS OF AS/NZS 5601.

INSTALLATION INSTRUCTIONS (continued)

Fitting the unit

- The unit should be fixed to the base of the fireplace with a screw to each front corner of the burner.
- Remove the front trim taking care of the wiring to the battery box or unplugging if necessary.

Gas

- Gas connection is to a ½" BSP barrel union connected to the control valve. This is located centrally under the unit. Take care to not damage the wiring loom
- Thoroughly blow out the supply pipe to clear any dust and debris.
- Ensure all connections are gas tight.
- Note: Do not bring the gas supply down the active chimney.

Coals

The Nectre Wonderfire has ceramic coals and a burner designed to appear like a wood/ coal fire. The unit is supplied with the ceramics assembled ready for operation.

- When the unit is unpacked check that no damage has occurred in transport.
- Carefully place the ceramic coal assembly on top of the burner making sure that it sits in place correctly.
- No other coals should be added as this will adversely affect the performance of the fire.
- Wash hands after handling the coals as they may contain toxic dyes.

INSTALLATION INSTRUCTIONS (continued)

FITTING TO AN EXISTING OPEN FIREPLACE

If installing the Wonderfire Electronic Valve (WEC) burner into an existing fireplace (without other options such as the Fan-Forced Convector Box), this is classed as a Type 1 appliance.

If the WEC burner is fitted into a Fan-Forced Convector Box (FFB), please refer to the Installation and Operating Manual for the FFB as there are additional installation requirements.

The fireplace enclosure must be fire resistive and must have a proved draught/working chimney.

The chimney must be swept and inspected to see if it is in sound condition.

The chimney must be a minimum area of 22,000mm² (i.e. a minimum of 150x150mm if square or 150mm diameter if round), and must extend to a height of at least 2.4m.

An approved 150mm diameter Gas Cowl must be fitted.

The flue or chimney of an open gas fire must be kept clear at all times. Devices which close or temporarily close the flue or chimney are not permitted. (e.g. a damper must be removed or securely disabled in the fully open position.)

If these conditions are met the chimney should usually provide satisfactory draw. In any event, the chimney and final installation must be tested for spillage into the room. This can be done by lighting a paper fire in the fireplace (before the appliance is installed) and holding a smoking twist of paper or a smoking match by the front of the fireplace. Air conditioning vents near the fireplace may also cause spillage.

The fireplace must be at least 470mm wide (front), 325mm wide (rear) x 240mm Deep x 400mm high to suit the WEC burner.

The room must have total fixed ventilation equal to the chimney / flue area.

THIS APPLIANCE REQUIRES FRESH AIR TO OPERATE SAFELY. THE ROOM WHERE THIS APPLIANCE IS INSTALLED MUST HAVE PERMANENT VENTILATION FROM OUTDOORS. THIS VENTILATION MUST NOT BE MODIFIED.

COMMISSIONING

- Once the fire is fitted and connected to the gas, the air bled from the supply pipe, prepare to test the unit's operation.
- Read pages 3-11 of this installation instructions first.
- Ensure the switch on the battery pack is in the "Off" position. Remove the plastic battery box cover (two screws) and fit 4 AA 1.5 volt batteries. A mains adapter can also be connected. Turn the gas supply on.
- Place the slider switch to the "Remote" position. Insert the end of a paper clip or other similar object into the hole marked PRG on the front cover. The receiver will beep 3 times.
- Insert the 3 AAA batteries in the remote controller. Push the "On" button. The receiver will beep 4 times. The remote controller is a radio operated unit, so needs to be in the proximity of the appliance but not necessarily pointing at it.
- Press the ON/OFF key on the remote. The appliance will beep once and the igniter should spark. It may take some time for the air to bleed from the system through the pilot. (a hand held gas lighter can be used to speed up this process). Ensure the thermometer symbol is neither "On" or "Smart" by pressing the thermostat key on the remote. Test the Hi to Low operation using the "Up/Down" button on the remote.
- After 10 minutes operation from cold, test for fireplace spillage, i.e. all products of combustion are entering the flue, by traversing the perimeter of the opening or canopy, using a smoke generator (e.g. a smoking twist of paper or smoke match).

MAINTENANCE / FAULT FINDING

It is recommended that new batteries be installed at the beginning of the heating season. Depending on the amount of use it is recommended that the unit be checked and serviced by a qualified gas fitter at the beginning of the heating season.

Please refer to the fault finding table as a trouble shooting guide.

Please refer to the section "Caring for Your Nectre Wonderfire" for user maintenance.

SERVICING DETAILS

The following notes are to assist a serviceman in the event of a malfunction.

- Servicing must only be carried out by authorised personnel.
- Spare parts and advice are available from Pecan Engineering Pty Limited.
- See also the Fault Finding chart.
- To Check Burner Pressure
- Gas consumption is 35 MJ/hr - **Natural Gas** Only.
- Test point pressures .88 kPa
- GAS CONNECTION – 15mm (1/2") Compression union
- ELECTRICAL CONNECTION – 3 Pin 10 Amp GPO plug
- POWER RATING OF APPLIANCE – 230V 50Hz 0.40Amp
- Working pressure required to operate appliance Natural gas 1.13kPa – 3.45kPa

SERVICING DETAILS (continued)

GAS CONTROL - Proflame 885

The SIT electronic gas control and valve is situated under the burner tray. To access; remove the coals and disconnect the gas supply. Remove the burner and place upside down on a flat surface covered with old newspaper.

All wiring diagram is connected by non interchangeable plugs and sockets.

The burner pressure test point is on the front centre of the valve. It is the lower test point, the upper being the inlet gas pressure.

Remove test point plug and connect manometer. Switch the gas and appliance on. Take pressure reading once unit is running and it should be within tolerance. Turn unit and gas off, disconnect manometer and tighten test point plug.

BURNER PRESSURE ADJUSTMENT

Burner test point pressures must be checked whilst appliance is running. Pressures are not adjustable. Pilot pressure is adjustable.



Burner pressure test point

Inlet gas pressure test point

Pilot pressure adjustment screw

SERVICING DETAILS (continued)

BURNER

To access the burner remove the coals. The burner is glued in to the burner tray. Examine it for any damage and check the venturi at the rear for lint and dust. Carefully clean as required.

Ensure that the main injector is located centrally with respect to the venturi.

PILOT

The pilot is located at the front of the burner. The spark gap should be 2 to 3mm.

When servicing the fire, be sure to clean the air intake hole of the pilot light.

AERATION ADJUSTMENTS

The aeration is factory set and fixed on all burners and should not be adjusted..

GAS VALVE REMOVAL

1. Turn off mains power to appliance.
2. Allow to cool
3. Lift up and off media set from burner assembly
4. Remove lower panel.
5. Turn off gas isolation valve to heater.
6. Unscrew burner retaining screws at front. 2 off.
7. Lift burner for access.
8. Disconnect heater from gas isolation valve.
9. Remove burner from appliance
10. Disconnect burner gas pipe from outlet of valve.
11. Disconnect pilot gas tube (recommend firebox end is disconnected).
12. Disconnect sparkler and flame sense lead from valve.
13. Disconnect gas pipe assembly.
14. Remove screws holding valve
15. Remove gas pipe
16. Remove valve.

To refit reverse instructions – Note ensure injector lines up correctly with burner entry port when refitting.

ROOM AIR FAN REPLACEMENT

1. Isolate power supply from appliance.
2. Remove front trim
3. Slide out fan assembly.
4. Disconnect wires and remove fan and fan slide plate.

HEAT EXCHANGER CLEANING

Under normal operation the heater exchanger requires minimal cleaning. Excessive dust, fibres pet / animal hair may reduce the heat exchangers performance.

The room air side of the heat exchanger can be cleaned by compressed air and vacuuming around the entry / exit points.

The flue gas side of the heat exchanger under normal operation should not require cleaning. Where cleaning or blockage removal is required, compressed air and brushes can be used to remove the restriction.

FAULT FINDING CHART

Fault	Possible Cause	Corrective Action
Igniter does not spark.	Spark rod at pilot light shorting. Faulty spark cable. Spark cable disconnected.	Clean Insulator or replace If damaged. Replace (with genuine part only). Reconnect.
Igniter sparks but No ignition at pilot light.	Low batteries. No Gas.	Replace batteries with new good quality ones. Check supply. Check AC/DC Power Pack is plugged in and turned on.
Gas ignites at Pilot light but goes out after 5 to 10 seconds.	Air in line. Pilot light injector blocked. Low gas pressure Pilot light air intake blocked (yellow pilot flame). Flame sensor cable disconnected.	Purge gas line. Note: reset Igniter by pressing the on/off switch. Clear blockage or replace pilot light. Check incoming gas supply pressure. Clear Pilot Light air intake hole(s) Inspect cable and reconnect.
Gas ignites at main burner but goes out.	Problem with the pilot light.	See above.
	Low batteries. Gas supply line too long and/or too small. Gas supply line partly blocked.	Replace batteries with new good quality ones. Check gas pipe size against AGA code for the Mjoule rating of appliance. Clear blockage.
Remote does not communicate	Low Batteries. AC/DC Power Pack faulty or not turned on Unit Switch is "On" or "Off".	Replace batteries. Check AC/DC Power Pack. Change to "Remote".

SEQUENCE OF OPERATION

1. Remote control calls for heat and sends signal.
2. Signal received by receiver. Beep sound should be audible from appliance.
3. Receiver performs internal safety check.
4. Gas control actuates pilot gas and starts ignition of pilot.
5. Ignition sparks for pilot.
6. Upon pilot lighting flame sensing occurs and sparking stops.
7. Main valve opens allowing main burner to cross ignite from pilot.
8. Heater will operate as per remote settings.
9. Remote control sends signal to stop heat.
10. Signal received by receiver. Audible beep from appliance should be heard.
11. Gas control turns off main burner and pilot.

REGULATOR ADJUSTMENT & CONVERSION DETAILS

Regulator where fitted is not adjustable – refer valve adjustments.

Appliance is Natural gas only – conversion not permitted.

WIRING DIAGRAM

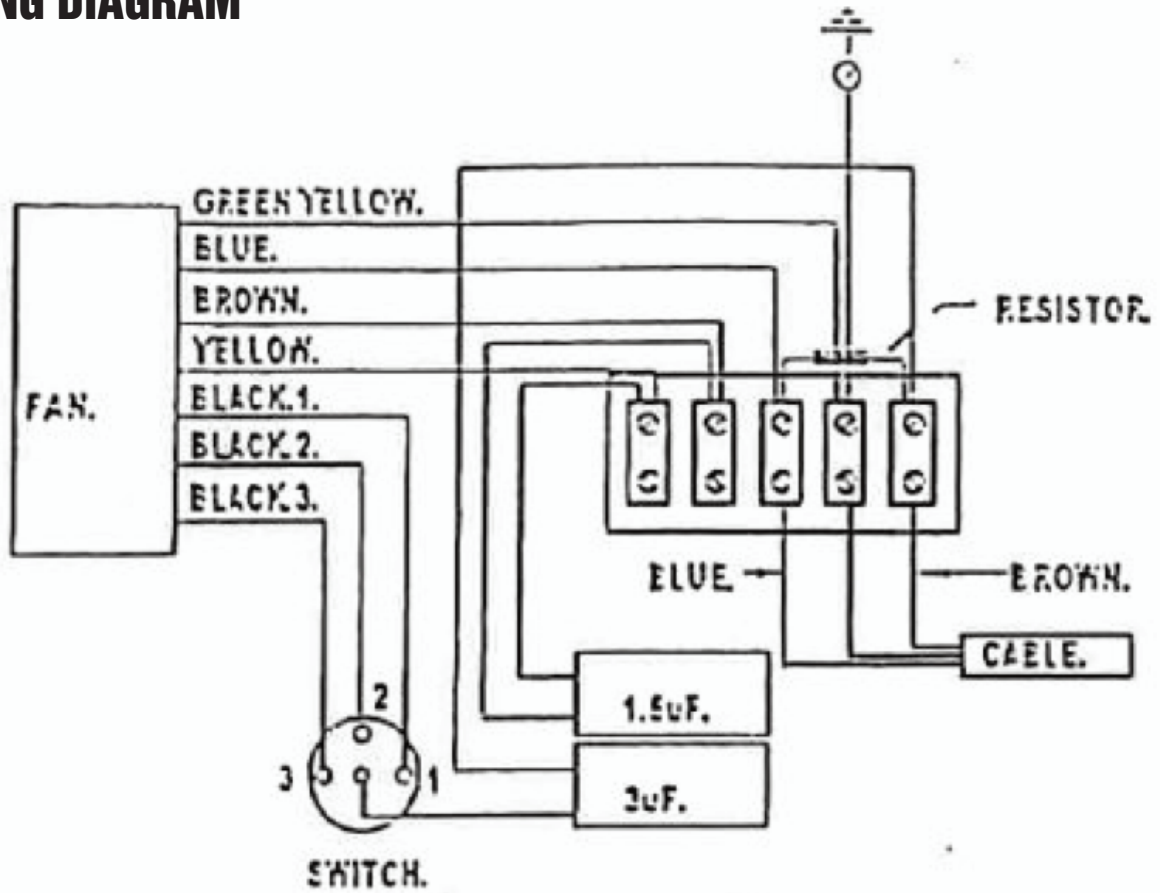



GLEN DIMPLEX AUSTRALIA PTY LTD

ABN 69 118 275 460

Head Office

8 Lakeview Drive, Scoresby, VIC 3179